



A **VOXX** ELECTRONICS COMPANY

Installation Guide

AHD QUAD Monitor / 250-8222

VOXX **Electronics**
SM
Corporation

A **VOXX** INTERNATIONAL COMPANY

own the drive.™

Specification



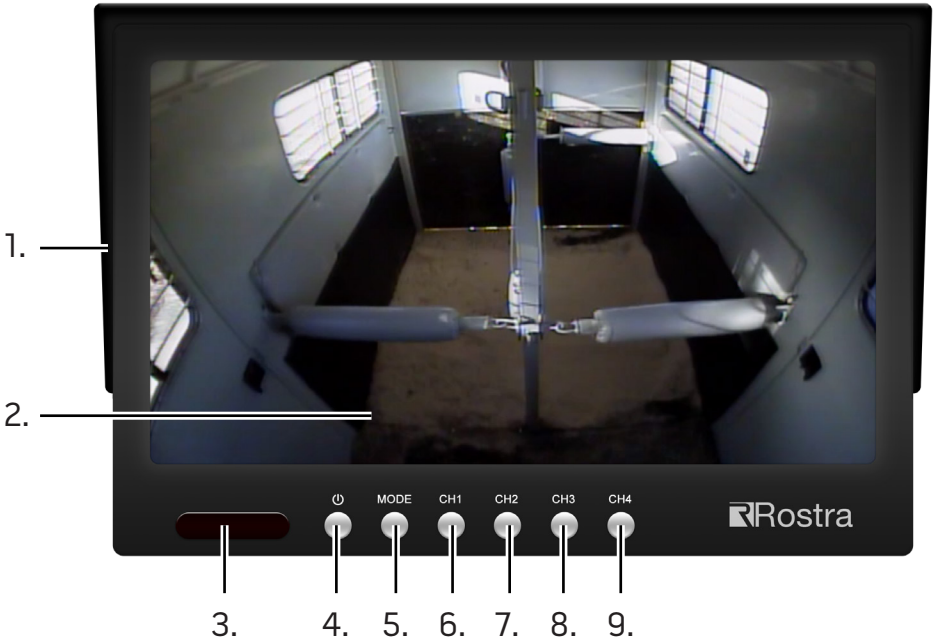

Screen size	7 inch
Aspect ratio	16:9
Luminance	500cd/m ²
Resolution	1024 x 600
Video	4 Video Inputs (AHD & CVBS)
Display mode	Single, Dual, Triple, Quad Views
System	NTSC / PAL
Voltage	12V-24V
Bracket accessories	Dash Mount Bracket
Sunshade	Yes
Built-in speaker	Yes
Storage temperature	-30~ +85 °C
Working temperature	-20~ +70 °C
OSD menu	Color, Brightness, Contrast, Volume, Image Flip, Language
Accessories	Power cable, Remote Control, Bracket, User manual.

Monitor Layout

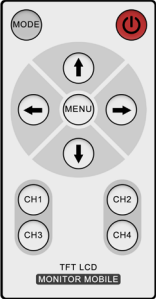

1. Sun Shade
2. Display Screen
3. Remote IR Sensor
4. Power Button
5. Mode Button (Toggle Viewing Modes)
6. Ch. 1
7. Ch. 2
8. Ch. 3
9. Ch. 4

Kit Contents

Remote Control *1PCS	Power Cable *1PCS	Bracket *1PCS
		
User Manual *1PCS	Adapter Cable *1PCS	
		

Kit Contents

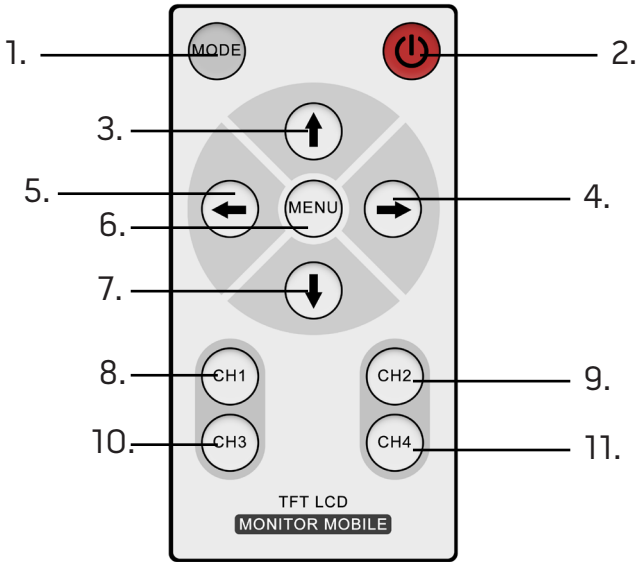

- | | |
|----------|---------|
| 1. Mode | 7. Down |
| 2. Power | 8. CH1 |
| 3. Up | 9. CH2 |
| 4. Right | 10. CH3 |
| 5. Left | 11. CH4 |
| 6. Menu | |

Connection

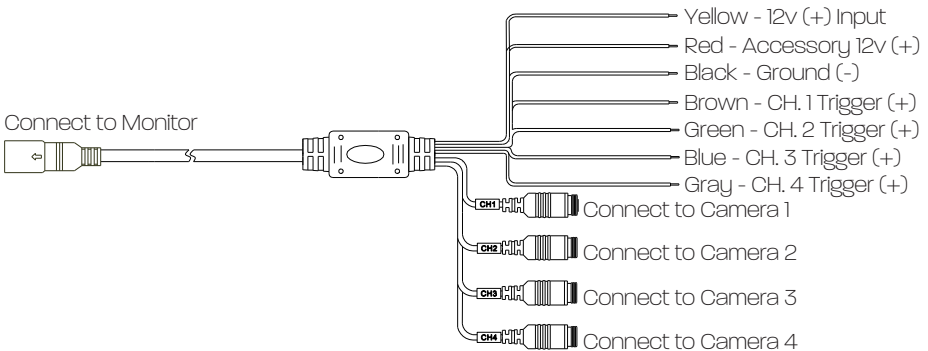

Installation

1. The mounting bracket can be secured using the 2 sided tape, screws or both. It is recommended to screw the bracket to the mounting location to ensure the monitor will not become loose in an accident. Use screws to install the bracket tightly to the mounting location. Loosen the mounting screw on the top of the bracket and insert the mounting nut into the channel on the rear of the monitor. (See below pictures)

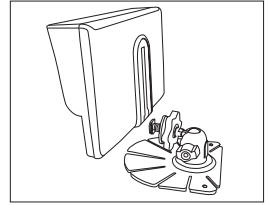
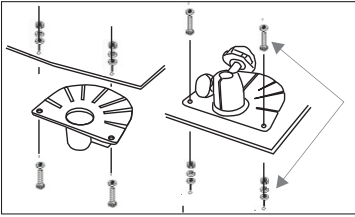

2. Move the bracket to the proper location and tighten the mounting screw to set the monitor to the proper height. (See below pictures)

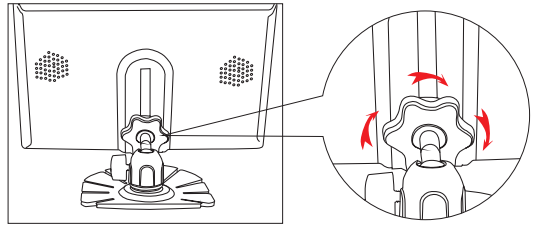
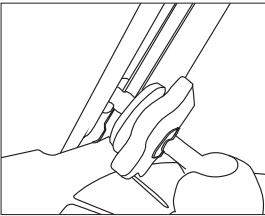

3. The monitor position can be adjusted by loosening the screw on the lower part of the bracket. Once the desired position is achieved, tighten the screw to secure the monitor into position. (See below pictures)

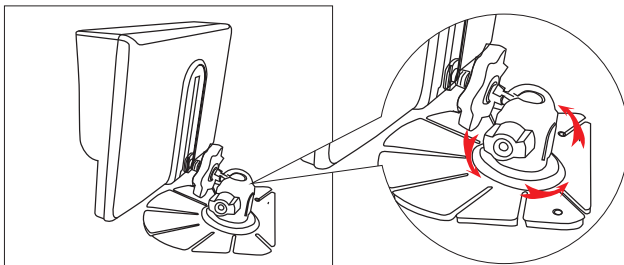



36 MONTH LIMITED WARRANTY

Voxx Electronics Corporation (the Company) warrants to the original purchaser of this product that should this product or any part thereof, under normal use and conditions, be proven defective in material or workmanship within 36 months from the date of original purchase, such defect(s) will be repaired or replaced with new or reconditioned product, (at the Company's option) without charge for parts or repair labor. A transmitter for a vehicle security or remote start system is warranted for 12 months from the date of original purchase.

To obtain repair or replacement within the terms of this Warranty, the product is to be delivered with proof of warranty coverage (e.g. dated bill of sale), authorization number, specification of defect(s), transportation prepaid, to an approved warranty station. This warranty is not transferable.

This Warranty does not cover damage to the vehicle's electrical system or costs incurred for the installation, removal or reinstallation of the product. This Warranty does not cover batteries, broken LCD transmitter display screens, nor apply to any product or part thereof which, in the opinion of the Company, has suffered or been damaged through alteration, improper installation, mishandling, misuse, abuse, neglect, accident, or by removal or defacement of the factory serial number/bar code label(s).

This Warranty is in lieu of all other express warranties or liabilities. ANY IMPLIED WARRANTIES, INCLUDING ANY IMPLIED WARRANTY OF MERCHANTABILITY, SHALL BE LIMITED TO THE DURATION OF THIS WRITTEN WARRANTY. ANY ACTION FOR BREACH OF ANY WARRANTY HEREUNDER INCLUDING ANY IMPLIED WARRANTY OF MERCHANTABILITY MUST BE BROUGHT WITHIN A PERIOD OF 24 MONTHS FROM DATE OF ORIGINAL PURCHASE. IN NO CASE SHALL THE COMPANY BE LIABLE FOR ANY CONSEQUENTIAL OR INCIDENTAL DAMAGES FOR BREACH OF THIS OR ANY OTHER WARRANTY. No person or representative is authorized to assume for the Company any liability other than expressed herein in connection with the sale of this product.

The company does not warrant that this product cannot be compromised or circumvented. THE EXTENT OF THE COMPANY'S LIABILITY UNDER THIS WARRANTY IS LIMITED TO THE REPAIR OR REPLACEMENT PROVIDED ABOVE AND, IN NO EVENT, SHALL THE COMPANY'S LIABILITY EXCEED THE PURCHASE PRICE PAID BY PURCHASER FOR THE PRODUCT WITHOUT INSTALLATION LABOR.

Some states do not allow limitations on how long an implied warranty lasts or the exclusion or limitation of incidental or consequential damage so the above limitations or exclusions may not apply to you. This Warranty gives you specific legal rights and you may also have other rights which vary from state to state.

Voxx Electronics Corporation, 2351 J. Lawson Blvd., Orlando, Florida 32824



For Customer Service
Visit Our Website At
www.voxxelectronics.com
Product Information, Photos,
FAQ's, Owner's Manuals