

**GENERAL APPLICABILITY**

FORD FIESTA ( AT/MT)

**KIT CONTENTS/SERVICE PARTS**

| ITEM | QTY | DESCRIPTION             | PART#    |
|------|-----|-------------------------|----------|
| 1    | 1   | CRUISE CONTROL MODULE   | 250-2813 |
| 2    | 1   | PEDAL INTERFACE HARNESS | 250-2821 |
| 3    | 1   | DIAGNOSTICS HARNESS     | 250-2785 |
| 4    | 1   | HARDWARE KIT            | 250-2767 |
|      |     |                         |          |
|      |     |                         |          |
|      |     |                         |          |
|      |     |                         |          |

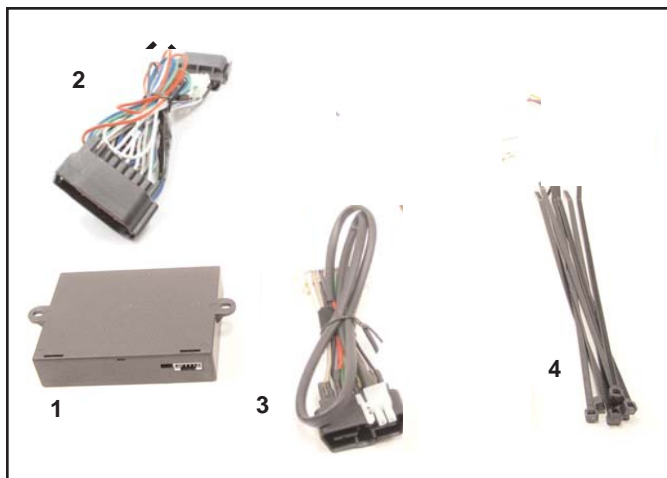

**HARDWARE BAG CONTENTS**

| ITEM | QTY | DESCRIPTION   |
|------|-----|---------------|
| 1    | 8   | WIRE ZIP TIES |
| 2    |     |               |
| 3    |     |               |







**RECOMMENDED TOOLS**

| PERSONAL & VEHICLE PROTECTION |                      |
|-------------------------------|----------------------|
| SAFETY GLASSES                |                      |
|                               |                      |
| SPECIAL TOOLS                 |                      |
| VOLT-OHM METER                |                      |
| INSTALLATION TOOLS            |                      |
| TRIM REMOVAL TOOL             | PHILLIPS SCREWDRIVER |
| 10-MM WRENCH                  |                      |
| SOLDERING TOOL                |                      |
| SPECIAL CHEMICALS             |                      |
|                               |                      |
|                               |                      |
|                               |                      |
|                               |                      |

**CONFLICTS**

NOTE:

**LEGEND**

-  **STOP:** DAMAGE TO VEHICLE MAY OCCUR. DO NOT PROCEED UNTIL PROCESS COMPLIANCE HAS BEEN MET.
-  **OPERATOR SAFETY:** USE CAUTION TO AVOID RISK OF INJURY.
-  **CRITICAL PROCESS:** PROCEED WITH CAUTION TO ENSURE A QUALITY INSTALLATION. THESE POINTS WILL BE AUDITED ON A COMPLETED VEHICLE INSTALLATION.
-  **GENERAL PROCESS:** THIS HIGHLIGHTS SPECIFIC PROCESSES TO ENSURE A QUALITY INSTALLATION. THESE POINTS WILL BE AUDITED DURING THE ACCESSORY INSTALLATION.
-  **TOOLS & EQUIPMENT:** THIS CALLS OUT THE SPECIFIC TOOLS AND EQUIPMENT REQUIRED FOR THE PROCESS.
-  **REVISION MARK:** THIS MARK HIGHLIGHTS A CHANGE IN INSTALLATION WITH RESPECT TO PREVIOUS ISSUE.



**WARNING: DO NOT USE HAND-HELD 2-WAY TRANSCEIVERS INSIDE YOUR VEHICLE WHILE DRIVING.**

WHEN TRANSMITTING FROM INSIDE THE CAR, 2-WAY RADIOS THAT OPERATE IN THE 25MHZ-700MHZ FREQUENCY RANGE WITH MORE THAN 2.0 WATTS OF POWER CAN PRODUCE ELECTROMAGNETIC INTERFERENCE THAT COULD INTERFERE WITH THE OPERATION OF Limiter AND THROTTLE CONTROLS RESULTING IN VEHICLE "LIMP MODE".

USE OF CELLULAR PHONES WILL NOT INTERFERE WITH THESE CONTROLS.



**DUE TO SENSITIVE NATURE OF SIGNALS USED FOR THIS PRODUCT, ALL NON-PLUG AND PLAY CONNECTIONS MUST BE SOLDERED. FAILURE TO COMPLY WITH THIS REQUIREMENT WILL VOID WARRANTY.**



## BEFORE INSTALLATION

To make the installation easier, the complete installation instructions should be read through before installation is started.

This installation instructions contains information how to install the Electronic Limiter Control which is not a Do-It-Yourself job.

Modern cars are equipped with electronics, which can be costly damaged by inappropriate treatment.

Rostra can not be held responsible for any error caused by wrong installation



## READ BEFORE INSTALLATION-IMPORTANT ADVISORY NOTES THAT YOU MUST FOLLOW

Always disconnect the negative cable from battery before installation.

Always use the enclosed installation instruction for installing the Electronic A Limiter Control.

Check the part number of the cruise module label is the same compared to the part number of the installation instructions.

Be aware of radio codes that might have to be typed in.

Find a location to install the cruise module and control switch

If any wires are left, then cut off and insulate.

Only use a multimeter to measure voltage.

Always drive the car for a complete test before assembling the car.

All wire leads must be soldered.

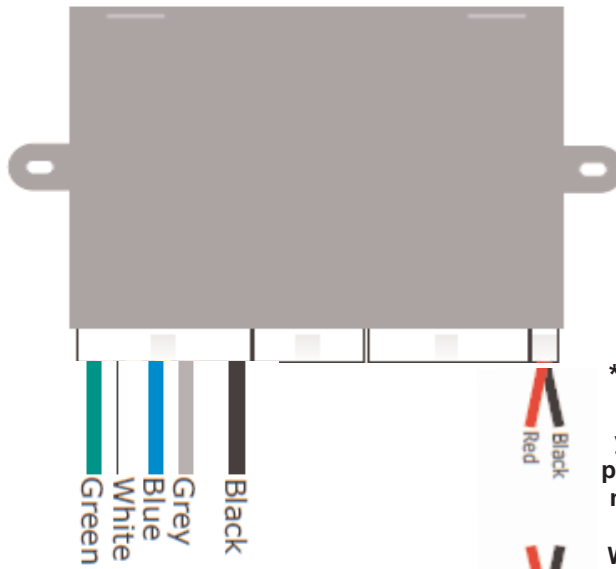
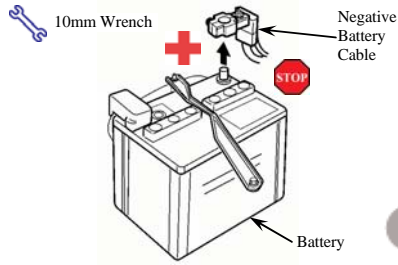

\*Note: If the OBD2 interface connector does not fit, or you do not want to use the plug cap, cut the Rostra connector off and solder wires: Red Wire to Pin 6, Black Wire to Pin 14 of OBD2 connector in the vehicle.

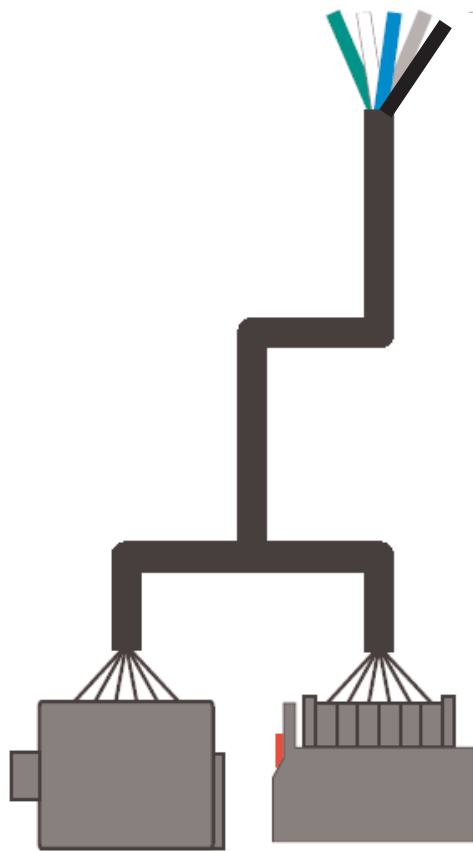
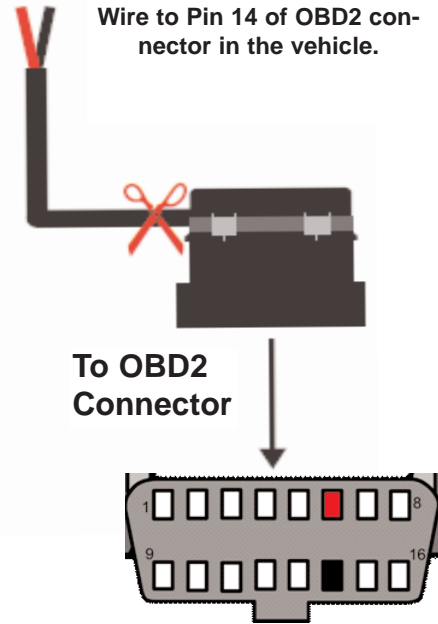

Connect to the  
accelerator pedal





Red

Ignition

Check ignition wire with a volt-meter to be sure voltage is 0V with key off and holds at +10V during crank/start

Connect RED wire from cruise harness to BROWN/YELLOW at IGNITION SWITCH 7 PIN CONN, PIN 1

Ford Fiesta

