

PART NUMBER: 250-9633-NS

GENERAL APPLICABILITY

ALL MODELS AT/MT
 NOTE:MANUAL TRANS. WILL REQUIRE 250-4206 CLUTCH SWITCH
 SOLD SEPARATELY

KIT CONTENTS/SERVICE PARTS

ITEM	QTY	DESCRIPTION	PART#
1	1	CRUISE CONTROL MODULE	250-2919
2	1	CLUTCH HARNESS	250-2759
3	1	PEDAL INTERFACE HARNESS	250-2869
4	1	DIAGNOSTICS HARNESS	250-2785
5	1	CONTROL SWITCH	250-2867



HARDWARE BAG CONTENTS

ITEM	QTY	DESCRIPTION
1	8	WIRE ZIP TIES
2		
3		







RECOMMENDED TOOLS

PERSONAL & VEHICLE PROTECTION	
SAFETY GLASSES	
SPECIAL TOOLS	
VOLT-OHM METER	
INSTALLATION TOOLS	
TRIM REMOVAL TOOL	PHILLIPS SCREWDRIVER
10MM WRENCH	
DRILL BITS	9.5MM OR 3/8" (FOR SWITCH)
14MM WRENCH	
SOLDERING TOOL	
SPECIAL CHEMICALS	

CONFLICTS

NOTE:250-4206 IS NEEDED FOR MANUAL TRANSMISSION ONLY. THIS PART IS SOLD SEPARATELY

LEGEND

-  **STOP:** DAMAGE TO VEHICLE MAY OCCUR. DO NOT PROCEED UNTIL PROCESS COMPLIANCE HAS BEEN MET.
-  **OPERATOR SAFETY:** USE CAUTION TO AVOID RISK OF INJURY.
-  **CRITICAL PROCESS:** PROCEED WITH CAUTION TO ENSURE A QUALITY INSTALLATION. THESE POINTS WILL BE AUDITED ON A COMPLETED VEHICLE INSTALLATION.
-  **GENERAL PROCESS:** THIS HIGHLIGHTS SPECIFIC PROCESSES TO ENSURE A QUALITY INSTALLATION. THESE POINTS WILL BE AUDITED DURING THE ACCESSORY INSTALLATION.
-  **TOOLS & EQUIPMENT:** THIS CALLS OUT THE SPECIFIC TOOLS AND EQUIPMENT REQUIRED FOR THE PROCESS.
-  **REVISION MARK:** THIS MARK HIGHLIGHTS A CHANGE IN INSTALLATION WITH RESPECT TO PREVIOUS ISSUE.



WARNING: DO NOT USE HAND-HELD 2-WAY TRANSCEIVERS INSIDE YOUR VEHICLE WHILE DRIVING.

WHEN TRANSMITTING FROM INSIDE THE CAR, 2-WAY RADIOS THAT OPERATE IN THE 25MHZ-700MHZ FREQUENCY RANGE WITH MORE THAN 2.0 WATTS OF POWER CAN PRODUCE ELECTROMAGNETIC INTERFERENCE THAT COULD INTERFERE WITH THE OPERATION OF CRUISE AND THROTTLE CONTROLS RESULTING IN VEHICLE "LIMP MODE".

USE OF CELLULAR PHONES WILL NOT INTERFERE WITH THESE CONTROLS.



DUE TO SENSITIVE NATURE OF SIGNALS USED FOR THIS PRODUCT, ALL NON-PLUG AND PLAY CONNECTIONS MUST BE SOLDERED. FAILURE TO COMPLY WITH THIS REQUIREMENT WILL VOID WARRANTY.



BEFORE INSTALLATION

TO MAKE THE INSTALLATION EASIER THE COMPLETE INSTALLATION INSTRUCTIONS SHOULD BE READ THROUGH BEFORE INSTALLATION IS STARTED.

THIS INSTALLATION INSTRUCTIONS CONTAINS INFORMATION HOW TO INSTALL THE ELECTRONIC CRUISE CONTROL WHICH IS NOT A Do-It-Yourself JOB.

MODERN CARS ARE EQUIPPED WITH ELECTRONICS WHICH CAN BE COSTLY DAMAGED BY INAPPROPRIATE TREATMENT.

ROSTRA PRECISION CONTROLS CAN NOT BE HELD RESPONSIBLE FOR ANY ERROR CAUSED BY IMPROPER INSTALLATION.



READ BEFORE INSTALLATION-IMPORTANT ADVISORY NOTES THAT YOU MUST FOLLOW

ALWAYS DISCONNECT THE NEGATIVE CABLE FROM BATTERY BEFORE INSTALLATION.

ALWAYS USE THE ENCLOSED INSTALLATION INSTRUCTIONS FOR INSTALLING THE ELECTRONIC CRUISE CONTROL.

CHECK THE PART NUMBER OF THE CRUISE MODULE LABEL IS THE SAME COMPARED TO THE PART NUMBER OF THE INSTALLATION INSTRUCTIONS.

BE AWARE OF RADIO CODES THAT MAY HAVE TO BE ENTERED.

FIND A LOCATION TO INSTALL THE CRUISE MODULE AND CONTROL SWITCH.

IF ANY WIRES ARE LEFT THEN CUT OFF AND INSULATE.

ONLY USE A MULTIMETER TO MEASURE VOLTAGE.

ALWAYS DRIVE THE CAR FOR A COMPLETE TEST BEFORE RE-ASSEMBLING THE CAR.

ALL WIRE LEADS MUST BE SOLDERED.

INSTALLATION

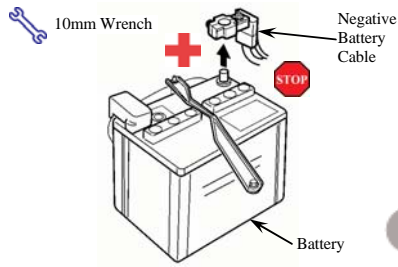

Connect data harness cap to OBD2 connector or

Optional *Cut the Rostra connector off and solder wires: Red wire to Pin 6, Black wire to Pin 14

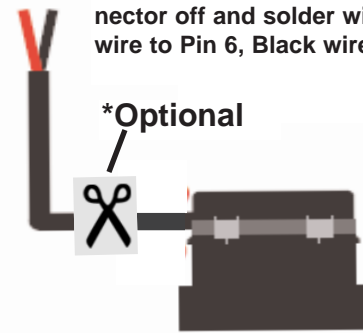

To OBD2 Connector

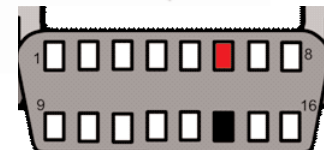

Connect to the accelerator pedal

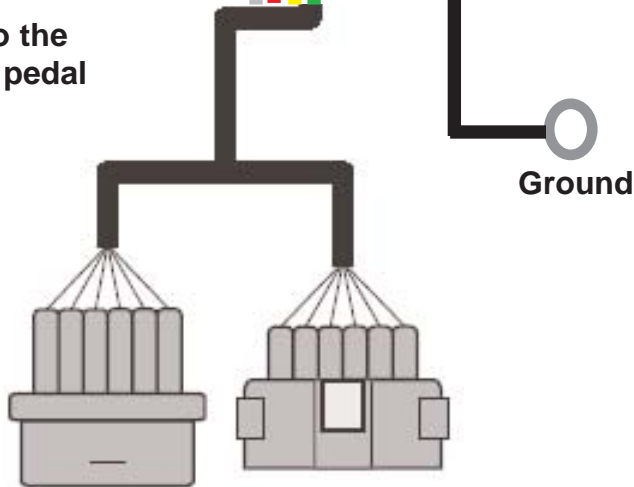

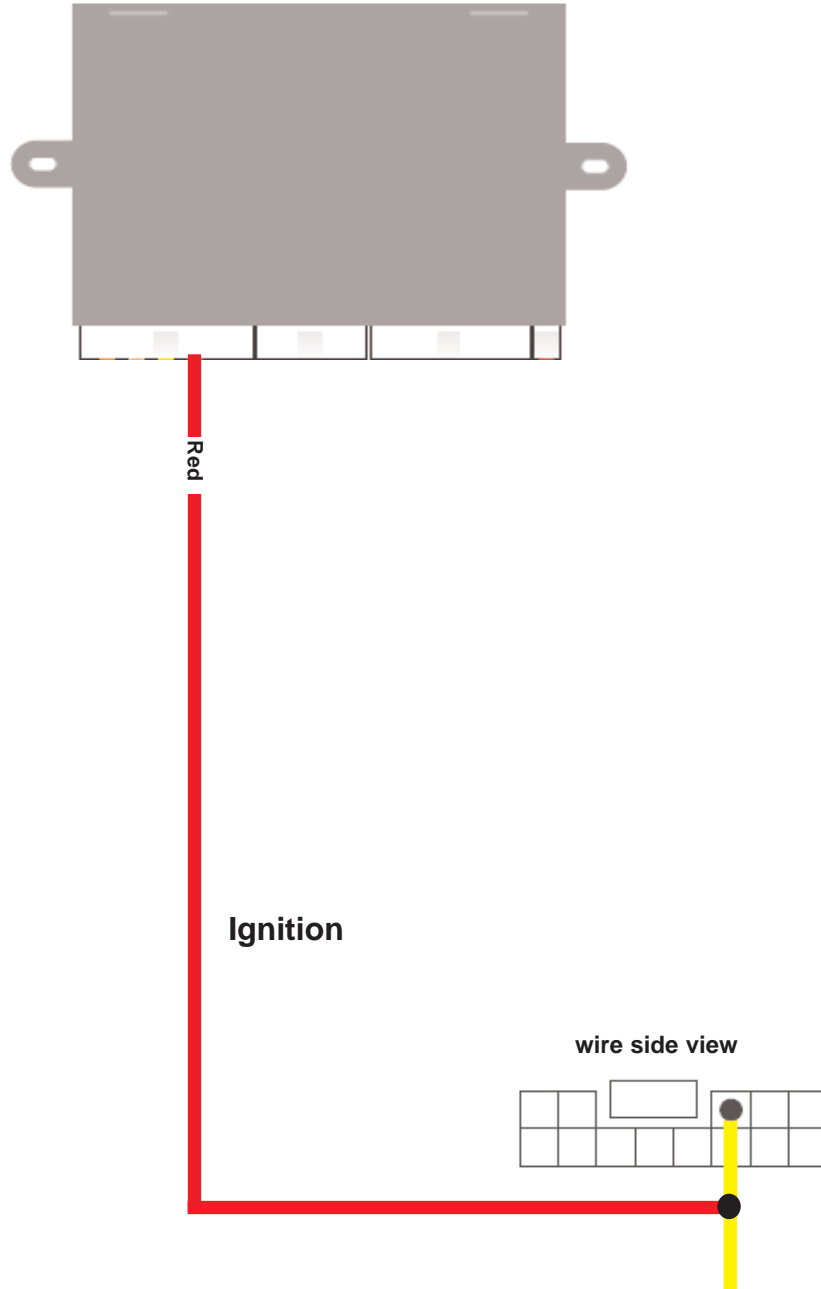

Connect to Yellow wire at White connector to the right of fuse box



FOR MANUAL TRANSMISSION ONLY
(WILL REQUIRE CLUTCH SWITCH 250-4206)

sold **SEPARATELY**

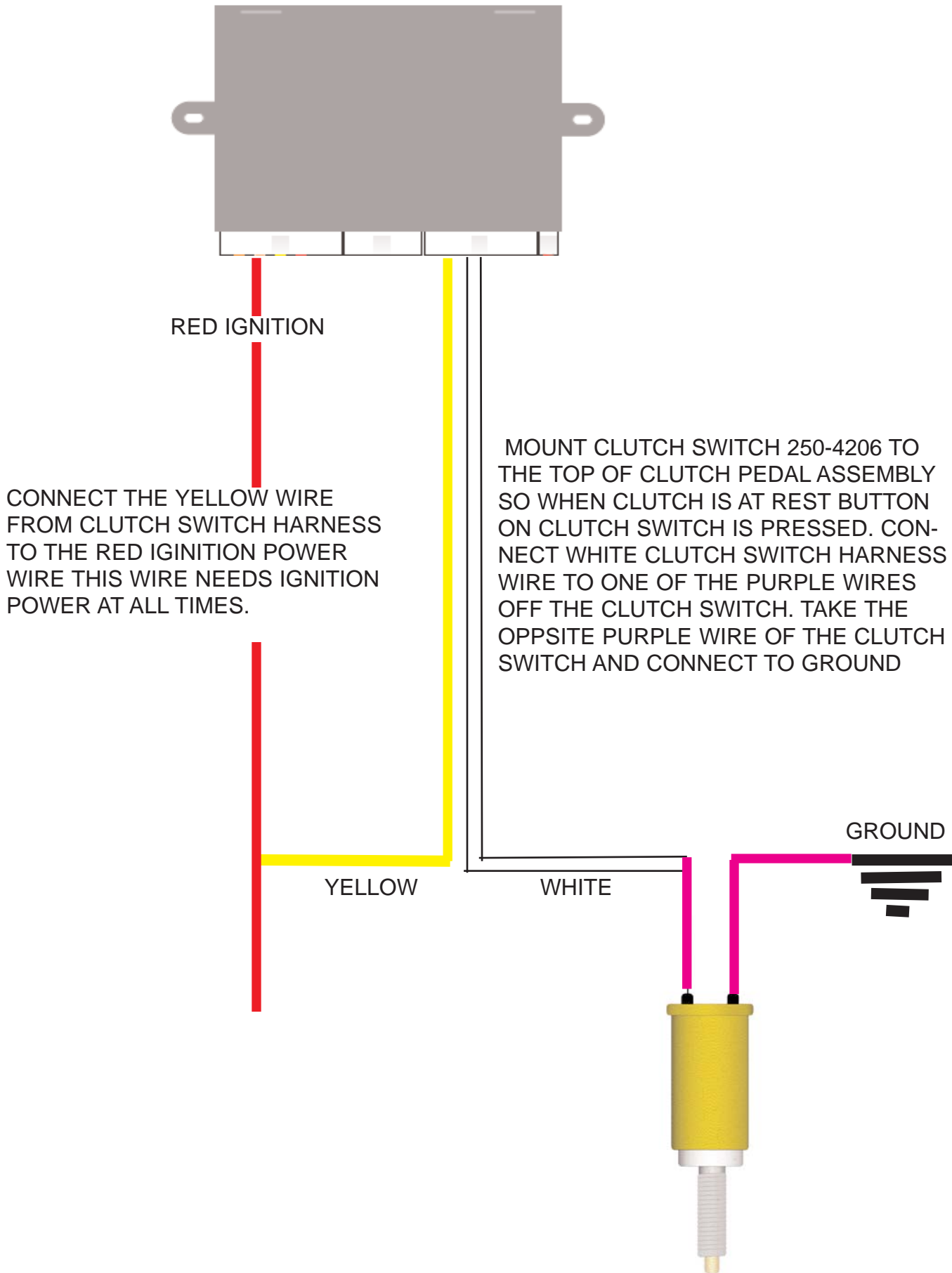

INSTALLATION

1. Find a suitable position for the switch on the left hand side of the covering around the steering column.
2. Mark the position and drill a 3/8 hole.
3. Use the enclosed fittings so the switch is angled to match the OE turn signal switch lever.
4. The switch head can be rotated as desired, and locked with the supplied retainer clip.
5. Insert the wires in the connectors to plug into cruise module shown below.

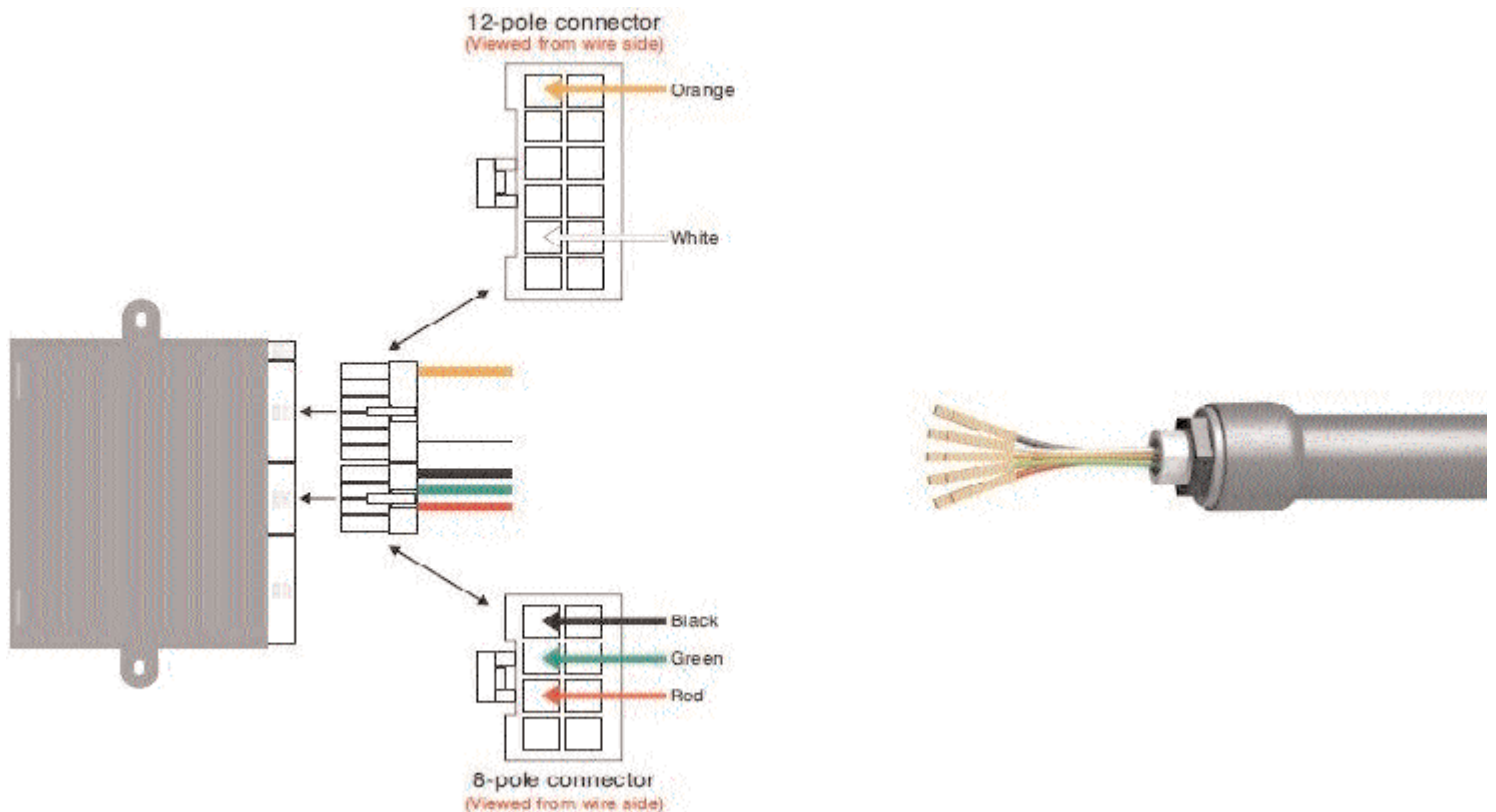
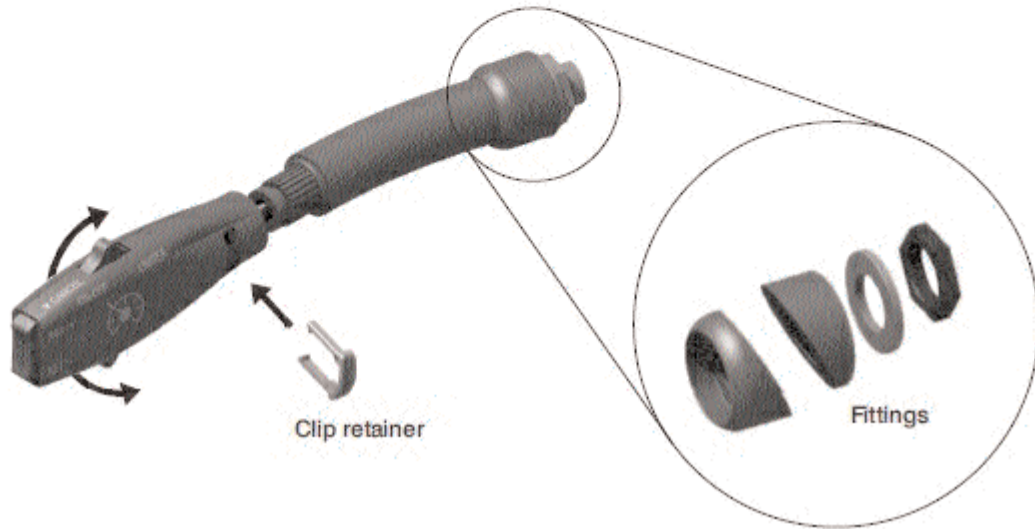

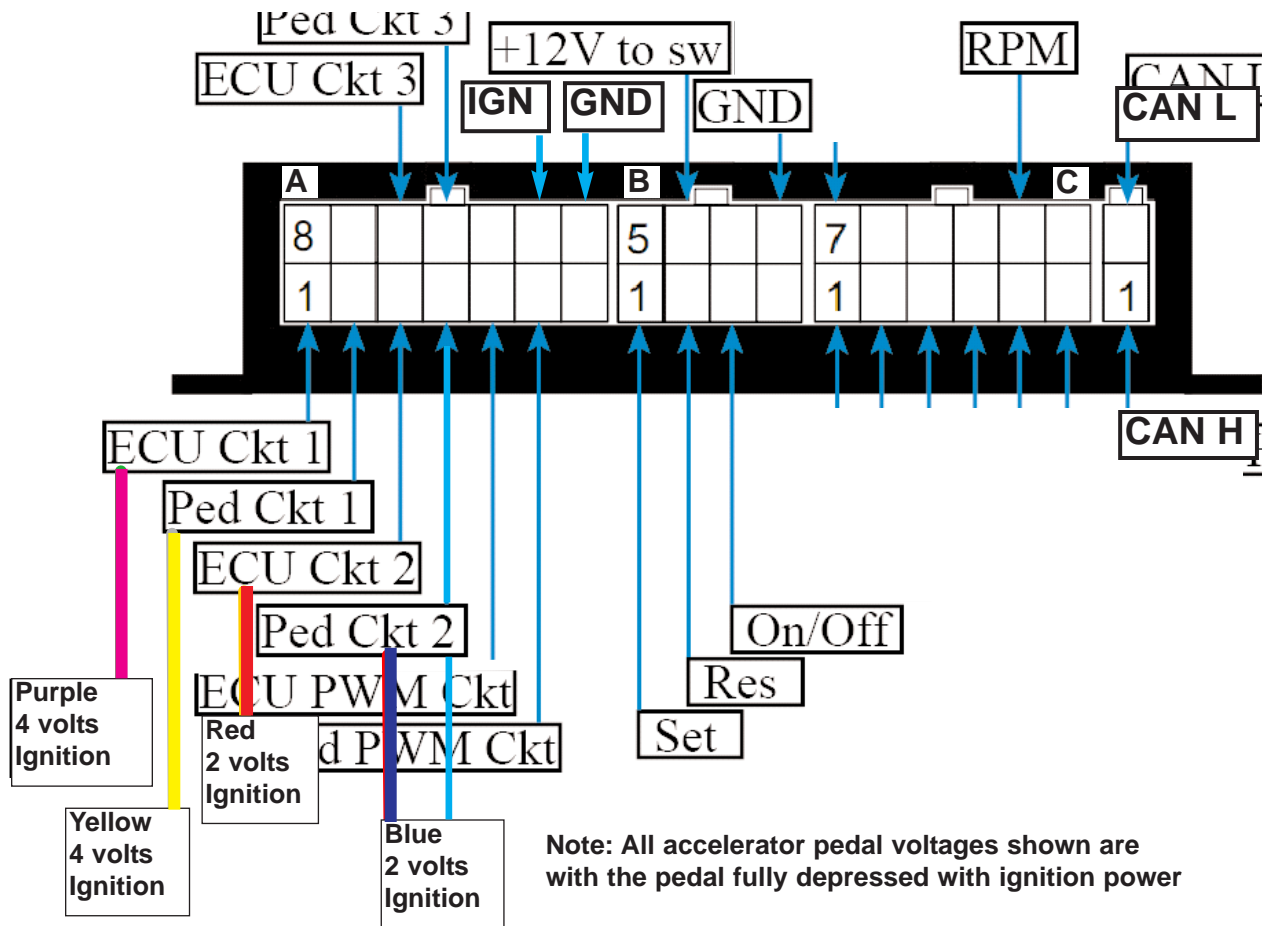

PIN	COLOR	DESIRED RESULTS	FAULT CONDITION
13A	RED	+12V WHEN SWITCHED ON AND +0V WHEN SWITCHED OFF. IGNITION MUST BE GREATER THAN +10V WHILE CRANKING VEHICLE.	NO POWER, VOLTAGE DROP OR INTERMITTENT CONNECTION WILL CAUSE LOSS OF PEDAL OR "LIMP MODE" CONDITION.
14A	BLACK	LOWEST RESISTANCE TO GROUND AND CLOSEST TO ZERO (0) OHMS AS POSSIBLE. USE A VEHICLE GROUND POINT WHERE OTHER GROUND WIRES ARE CONNECTED.	A BAD GROUND CONNECTION WILL CAUSE THE FOLLOWING CONDITIONS: CRUISE WILL NOT FUNCTION, LOSS OF PEDAL OR "LIMP MODE" CONDITION.
1B	GREEN	SET/COAST: 12V PRESS AND HOLD SET.	CRUISE WILL NOT SET IF THIS CONNECTION IS NOT INSTALLED CORRECTLY.
2B	YELLOW	RESUME/ACCEL: 12V PRESS AND HOLD RESUME.	CRUISE WILL NOT RESUME OR ACCEL IF THIS CONNECTION IS NOT INSTALLED CORRECTLY.
3B	BROWN	ON/OFF: 12V PRESS ON.	CRUISE WILL NOT SET IF THIS CONNECTION IS NOT INSTALLED CORRECTLY.
6B	RED AND BLUE	12V	CRUISE LIGHT WILL NOT COME ON IF THESE CONNECTIONS ARE NOT INSTALLED CORRECTLY.
8B	BLACK	(0) OHMS RESISTANCE TO GROUND.	



**Rostra
Precision
Controls, Inc.**