

General Applicability

This cruise control was tested and verified on:
 2009-2010 Ford F-150 / E-150
 2010 Ford Escape
 2009-2010 Mazda Tribute
 This cruise control may not function correctly on unverified vehicles. See www.rostra.com for vehicle compatibility.

Kit Contents

Item	Qty	Description	Service Part #
1	1	Cruise Control Module	250-2786
2	1	Switch Harness	250-2760
3	1	Main Wiring Harness	250-2759
4	1	Pedal Interface Harness	250-2761
5	1	Hardware Kit	250-2767
6	1	Control Switch	250-3742

Contents of Hardware Bag

Qty	Description
8	Wire Zip Ties

Kit Contents/Service Parts

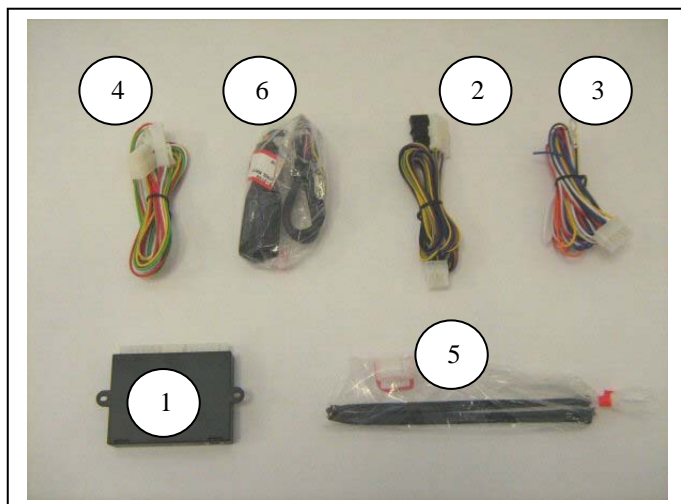

Recommended Tools

Safety Tools	
Gloves, Safety Glasses	
Special Tools	
Volt-Ohm Meter	
Installation Tools	
Side cutter	To cut wire ties
Drill Bit or Knockout Punch	9.5mm or 3/8" (for switch)
10mm wrench	
Soldering Tool	
Special Chemicals	

Conflicts

Note:

Legend

	STOP: Damage to the vehicle may occur. Do not proceed until process has been complied with.
	OPERATOR SAFETY: Use caution to avoid risk of injury
	CRITICAL PROCESS: Proceed with caution to ensure a quality installation.
	GENERAL PROCESS: This highlights specific processes to ensure a quality installation.
	TOOLS & EQUIPMENT: This calls out the specific tools and equipment required for this process



WARNING: DO NOT USE HAND-HELD 2-WAY TRANSCEIVERS INSIDE YOUR VEHICLE WHILE DRIVING WITH CRUISE CONTROL ENGAGED.

WHEN TRANSMITTING FROM INSIDE THE CAR, 2-WAY RADIOS THAT OPERATE IN THE 25-700 MHz FREQUENCY RANGE WITH MORE THAN 2.0 WATTS OF POWER CAN PRODUCE ELECTROMAGNETIC INTERFERENCE THAT COULD INTERFERE WITH THE OPERATION OF CRUISE AND THROTTLE CONTROLS RESULTING IN VEHICLE "LIMP MODE".

Use of cell phones will not interfere with these controls.



DUE TO SENSITIVE NATURE OF SIGNALS USED FOR THIS PRODUCT ALL NON PLUG AND PLAY CONNECTIONS MUST BE SOLDERED. FAILURE TO COMPLY WITH THIS REQUIREMENT WILL VOID WARRANTY.

Section I – Installation Procedure

A. Pre-Installation Suggestions

- 1.  It is advisable to disconnect the negative battery cable for 3 minutes before beginning installation, to avoid unintended air bag deployment. Note and record any anti-theft radio codes prior to disconnecting. **Figure 1**

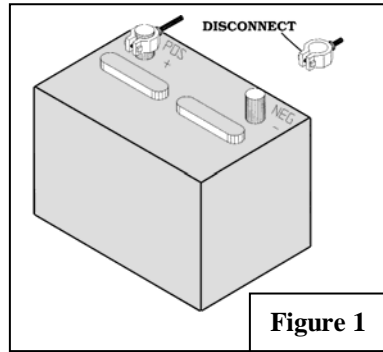



Figure 1

- 2. Remove the driver side lower dash and kick panels. Remove the steering wheel shroud. **Figure 2**



Figure 2

B. Install Electronic Module

- 1.  Plug the **Main Wiring Harness, Switch Harness, and Pedal Interface Harness** in to the mating connectors of the Cruise Control Module. **Figure 3**
- 2. Place the **Cruise Control Module** in a secure location behind the driver side dash area near the firewall away from moving parts. Secure with supplied wire ties.
- 3. Route the **Pedal Interface Harness** through steering column and down to the accelerator.
- 4.  Locate the 6 pin plug and mate connectors to the **Pedal Interface Harness**. Remove the accelerator 6-pin connector and apply to mating connector of **Pedal Interface Harness**. Apply the remaining connector to the accelerator. **Figure 4**

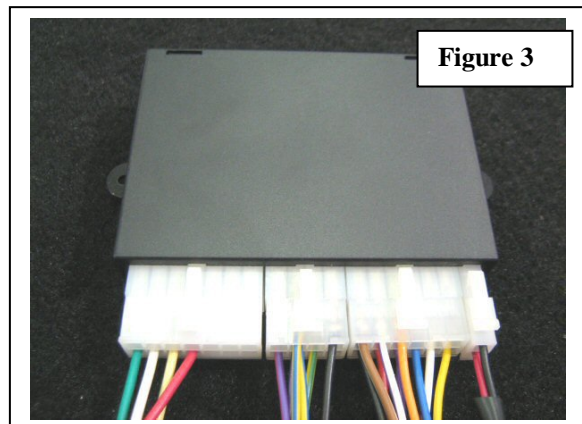

Figure 3

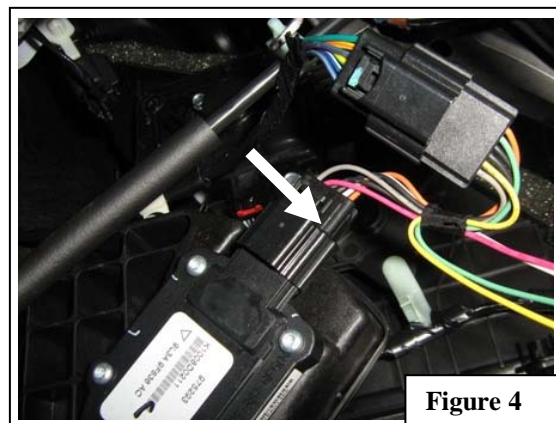

Figure 4

C. Ford F and E 150 Wiring Connections

(It is advisable to use solder for all wiring connections)



1. Locate the following wires to connect to the **Main Wiring Harness** from the control module:



Function	See Fig.	Vehicle Color
F-150 IGN	5	WHITE/LT. BLUE
E-150 IGN	6	BLUE
BRAKE +	7	BROWN/RED OR BEIGE/RED
BRAKE -	7	VIOLET/WHITE
GROUND	8-9	GROUND POINT
VSS	11	YELLOW

2. Connect the Main Harness to vehicle wire by using the chart below:

Function	Cruise Harness Color	Vehicle Wire
F-150 IGN	RED	LT.BLUE/WHITE
E-150 IGN	RED	BLUE
BRAKE +	BLUE	BROWN/RED
BRAKE -	WHITE/BROWN	VIOLET/WHITE
VSS	VIOLET	YELLOW

3. Apply the **Black Ground Wire** from the **Main Wiring Harness** to the Vehicle Ground Point behind the lower dash panel (F-150) in **Figure 8**, or behind the driver-side kick panel (E-150) in **Figure 9**.

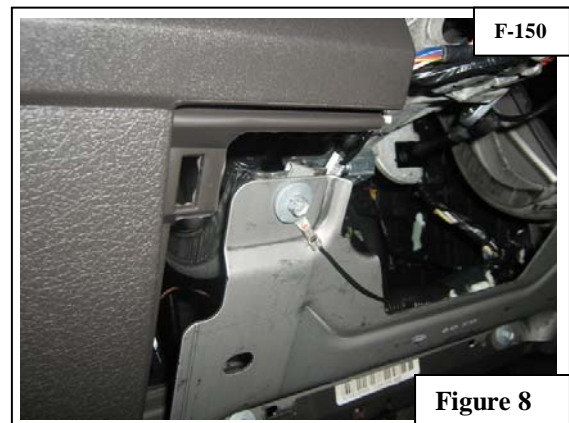
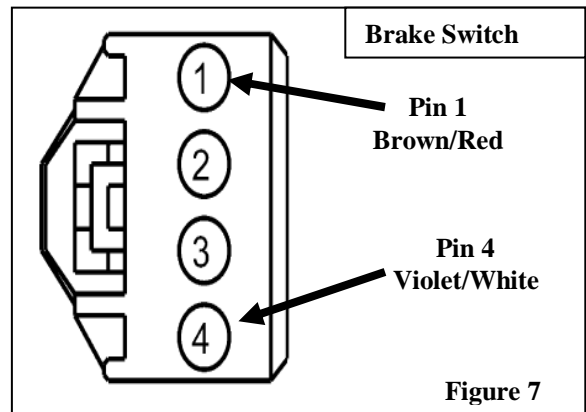
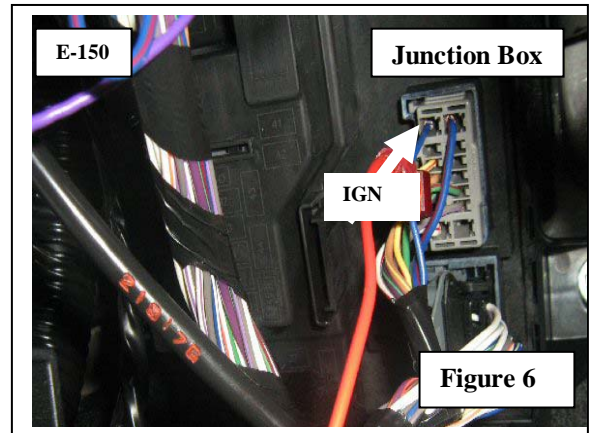
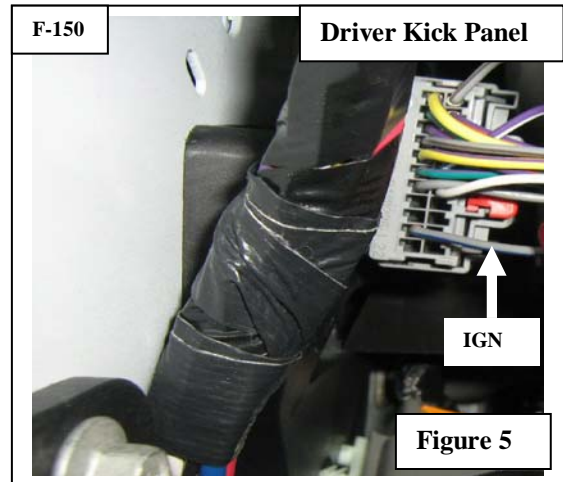

Ford F and E 150 Wiring Connections Continued...

- Route the **Violet** through grommet on firewall to antilock brake module located under the air intake system (**Figure 10**). Note: If extra length is needed, use the White/Purple wire to extend Violet Wire. Connect the **Violet Wire** from the **Main Wiring Harness** to the **Yellow Wire** (Vehicle Speed Sensor) in **Pin 28** of the antilock brake module. **Note: The yellow wire will be entwined with purple/white wire.** Apply the supplied weather sealant to the connection. Be sure all of connection is sealed properly. **Figure 11**

D. Mazda Tribute / Ford Escape Connections

(It is advisable use solder for all wiring connections)

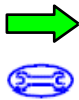

- Locate the following wires to connect to the main harness from the control module:

Function	See Fig.	Vehicle Color
IGN	12	YELLOW/GRAY
BRAKE +	13	YELLOW/RED
BRAKE -	13	VIOLET/WHITE
GROUND	14	GROUND POINT
VSS	15-16	GRAY/VIOLET
CLUTCH SWITCH	17	GREEN/WHITE

- Connect the Main Harness to vehicle wire by using the chart below:

Function	Cruise Harness Color	Vehicle Wire
IGN	RED	YELLOW/GRAY
BRAKE +	BLUE	YELLOW/RED
BRAKE -	WHITE/BROWN	VIOLET/WHITE
VSS	VIOLET	GRAY/VIOLET
CLUTCH SWITCH	WHITE	GREEN/WHITE

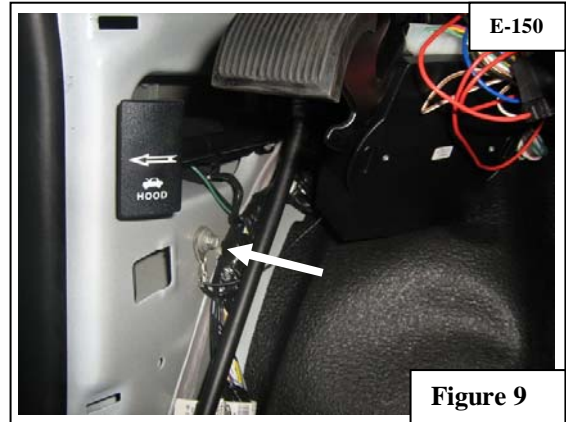

Figure 9

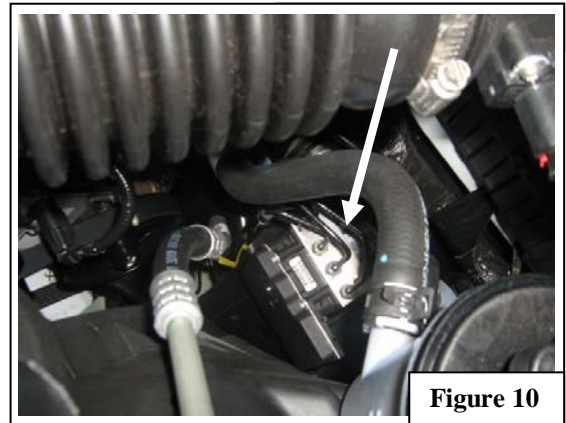

Figure 10

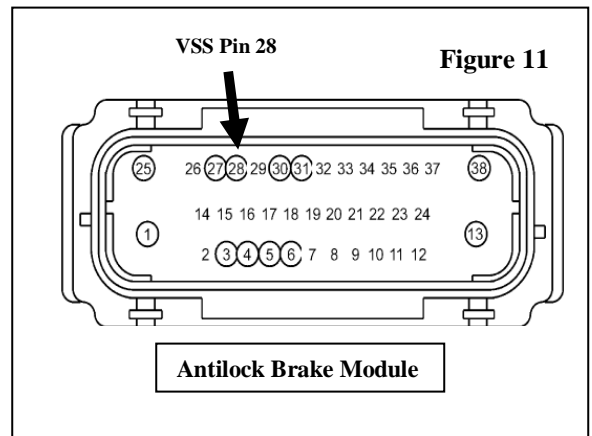

Figure 11

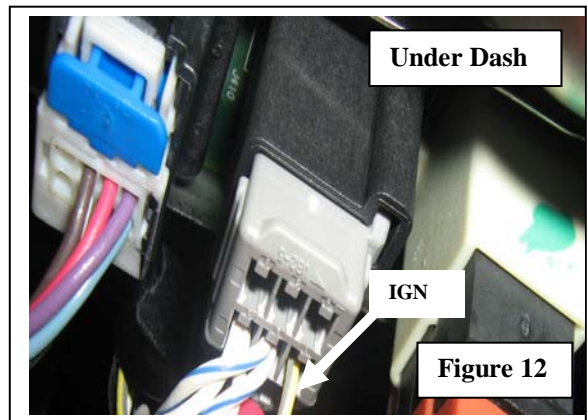

Figure 12

3. Apply the **Black Ground Wire** from the Main Harness to the Vehicle Ground Point behind lower dash panel. **Figure 14**

4. Route the **Violet Wire** through grommet on firewall to antilock brake module. Remove the air intake system to access ABS harness (**Figure 15**). Note: If extra length is needed, use the White/Purple wire to extend Violet Wire. Connect the **Violet Wire** from the **Main Wiring Harness** to the **Gray/Violet Wire** (Vehicle Speed Sensor) in **Pin 34** of the antilock brake module.

Note: The gray/violet wire will be entwined with violet wire. Apply the supplied weather sealant to the connection. Be sure all of connection is sealed properly. **Figure 16**

5. **Clutch Switch for Manual Transmissions:** Locate the black 2-pin connector on the clutch switch. Connect the **White Wire** from the Main Wiring harness to the **Green /White Wire** of the clutch switch. **Figure 17**

6. Secure Cruise Control and Switch Interface Module harnesses with zip ties away from moving parts.

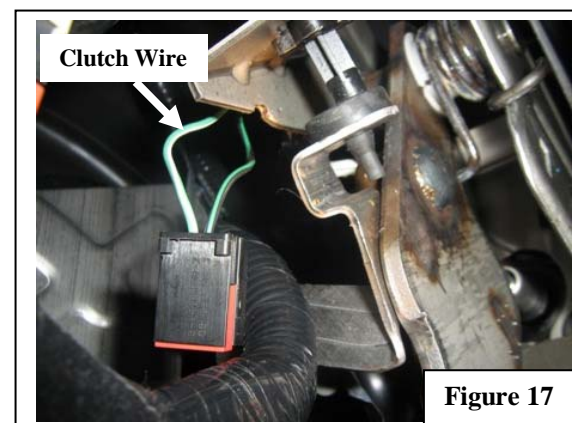
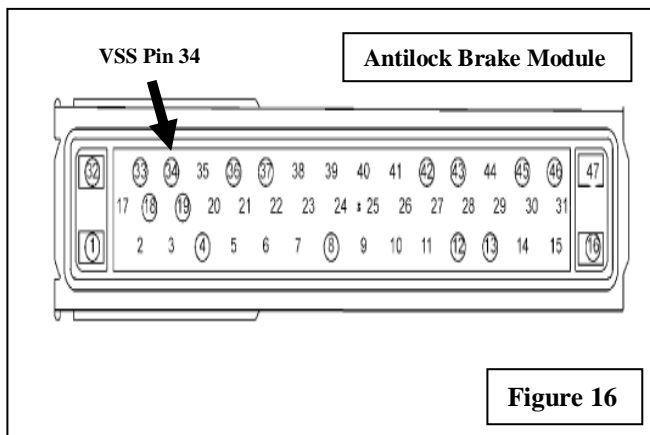
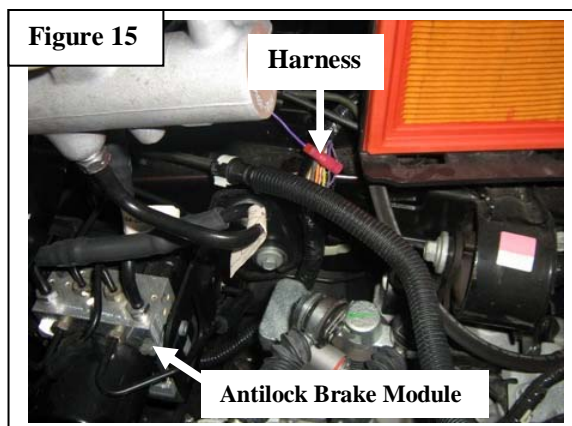
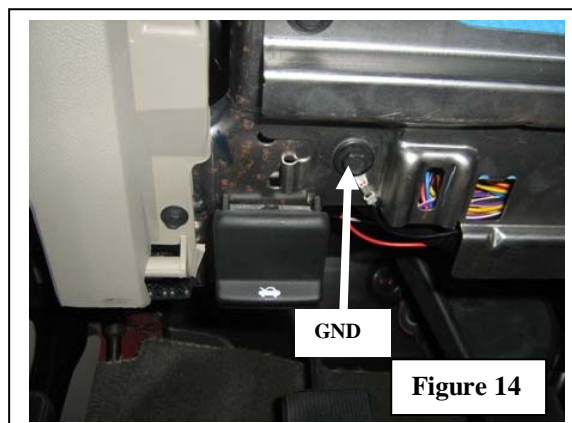
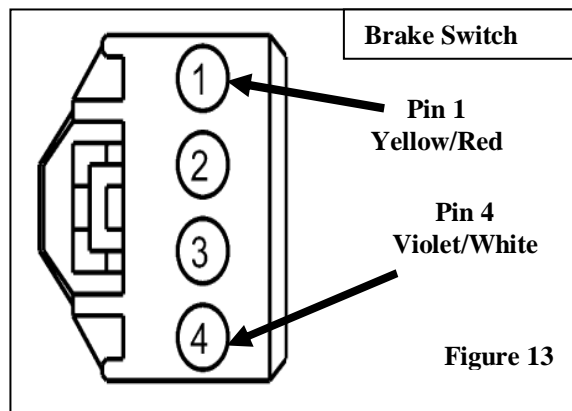

E. Install Control Switch



1. Use the **Lever Wedges** on the **Control Switch** as an angle template to drill a 3/8" or 9.5mm hole in the lower shroud of the steering column cover. Assemble **Control Switch** to the lower shroud of the steering column cover according to **Figure 18**.

2. Apply nut and position the **Control Switch** for highest driver visibility.

3. Assemble (2) 3-pin connectors from the sack parts to the mating wire colors on the **Switch Harness**. Use the diagram to mate the **Main Wiring Harness** to the **Switch Harness**. **Figure 19**

4. Route the assembled **Switch Harness** to the mating connector of the **Cruise Control module**.

5. Secure the **Switch Harness** with zip ties away from moving parts.

F. Testing



1. Reconnect negative battery cable and torque to 35 lbs. Reenter anti-theft radio codes.

2. Turn ignition on. Apply the on/off button of Cruise Control Switch.

G. Reassembly



1. Reinstall all removed pieces taking care to ensure harnesses and wiring connections are properly secured.

2. Make sure all harnesses are not pinched or bound by trim pieces.

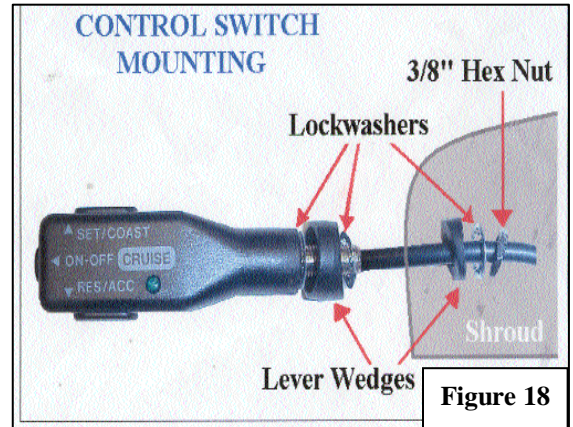

Figure 18

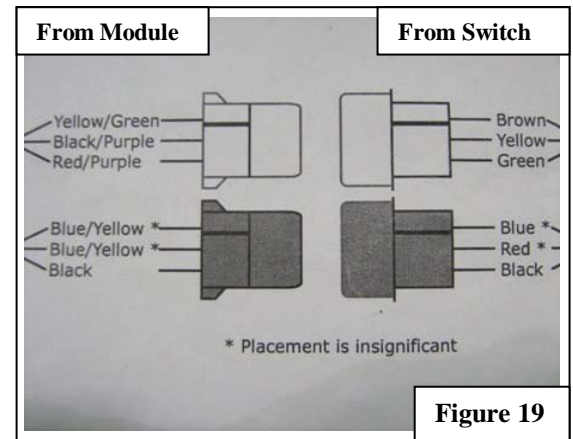

Figure 19



Figure 20

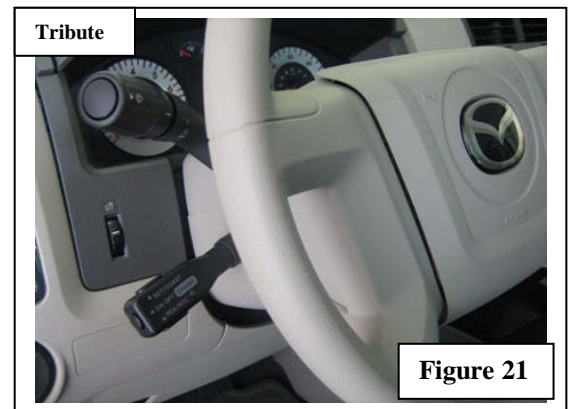
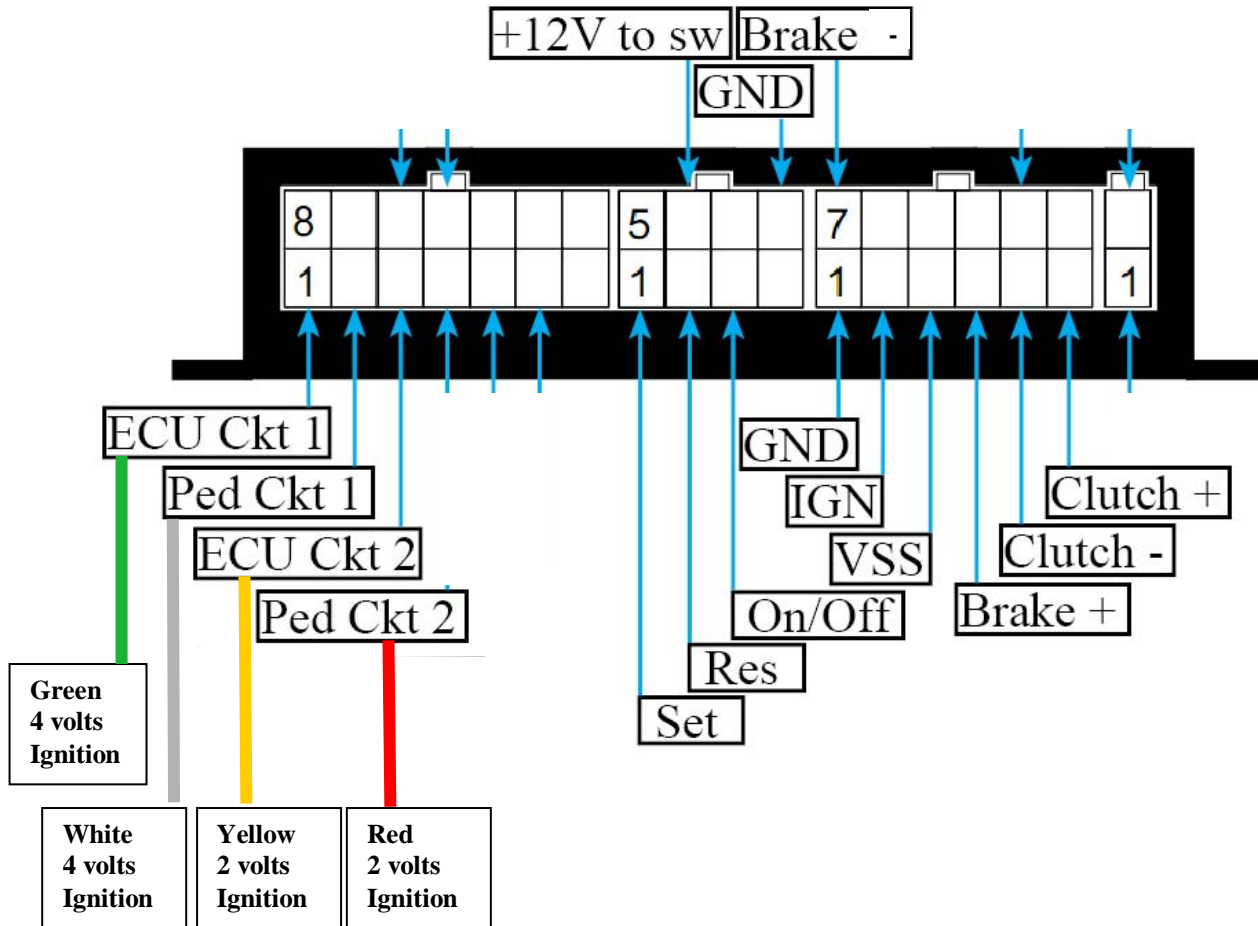



Figure 21



Note: All Pedal Interface Harness Voltages are with pedal fully depressed

Function	Color	Results	Fault Conditions
Ignition	Red	+12V when switched on and +0V when switched off. Ignition must be greater than +10V while cranking vehicle.	No power, voltage drop, or intermittent connection will cause Loss of pedal or "Limp Mode" condition.
Brake positive +	Blue	"Hot" side of brake switch. +12V all the time.	Cruise will not function if this connection is not installed correctly.
Brake negative -	Brown/White	"Cold" side of Brake switch. Zero (0) resistance to ground when brake is not pressed. +12V when brake is pressed.	Cruise will not function if this connection is not installed correctly. If connection is good, and there is a high resistance to ground, a 5 terminal relay will be required to complete installation. See diagram below.
Ground	Black	Lowest resistance to ground closest to zero (0) ohms as possible. Use a vehicle ground point where other ground wires are connected to.	A bad ground connection will cause the following conditions: Cruise will not function; Loss of pedal or "Limp Mode" condition.
Clutch (GND triggered)	White	Ground active wire at switch when clutch is depressed.	Cruise will not function if wrong wire is connected –OR–  Cruise will not disengage when clutch is depressed.
Clutch (+12V triggered)	Yellow	+12V active wire at switch when clutch is depressed.	Cruise will not function if wrong wire is connected –OR–  Cruise will not disengage when clutch is depressed.

5 Terminal Relay for Brake Switch

