

General Applicability

All Models

Item #	Qty.	Description
1. 250-2758	1	Cruise Control Module
2. 250-2760	1	Switch Harness
3. 250-2759	1	Main Wiring Harness
4. 250-2761	1	Pedal Interface Harness
5. 250-2762	1	Hardware Kit
6. 250-3742	1	Control Switch

Kit Contents/Service Parts

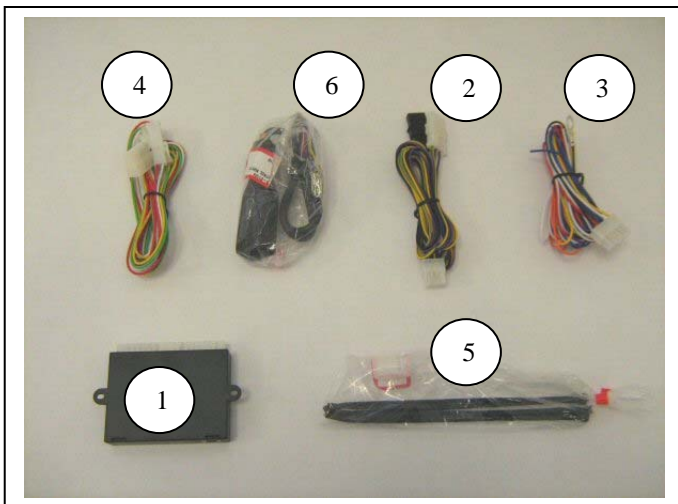

Contents of Hardware Bag, 250-2758

Qty	Description
8	Wire Zip Ties
2	Weather sealant

Additional Items Required For Installation



DUE TO SENSITIVE NATURE OF SIGNALS USED FOR THIS PRODUCT ALL CONNECTIONS MUST BE SOLDERED.

FAILURE TO COMPLY WITH THIS REQUIREMENT WILL VOID WARRANTY.

Recommended Tools

Safety Tools	
Gloves, Safety Glasses	
Special Tools	
Volt-Ohm Meter	
Installation Tools	
Side cutter	To cut wire ties
Drill Bit or Knockout Punch	9.5mm or 3/8" (for switch)
10mm wrench	
Soldering Tool	
Special Chemicals	





Conflicts

Note:

Recommended Sequence of Application

Item #	Accessory
1	
2	
3	

Legend

-  **STOP:** Damage to the vehicle may occur. Do not proceed until process has been complied with.
-  **OPERATOR SAFETY:** Use caution to avoid risk of injury
-  **CRITICAL PROCESS:** Proceed with caution to ensure a quality installation.
-  **GENERAL PROCESS:** This highlights specific processes to ensure a quality installation.
-  **TOOLS & EQUIPMENT:** This calls out the specific tools and equipment required for this process

Section I – Installation Procedure

A. Pre-Installation Suggestions

-  1. It is advisable to disconnect the negative battery cable for 3 minutes before beginning installation, to avoid unintended air bag deployment. Note and record any anti-theft radio codes prior to disconnecting. **Figure 1**



2. Remove the driver side lower dash and kick panels. Remove the steering wheel shroud. **Figure 2**



B. Install Electronic Module



1. Plug in the **Main Wiring Harness, Switch Harness, and Pedal Interface Harness** onto mating connectors of the Cruise Control Module. **Figure 3**
2. Place the **Cruise Control Module** in a secure location behind the driver side dash area near the firewall away from moving parts. Secure with supplied wire ties.
3. Route the **Pedal Interface Harness** through steering column and down to the accelerator.

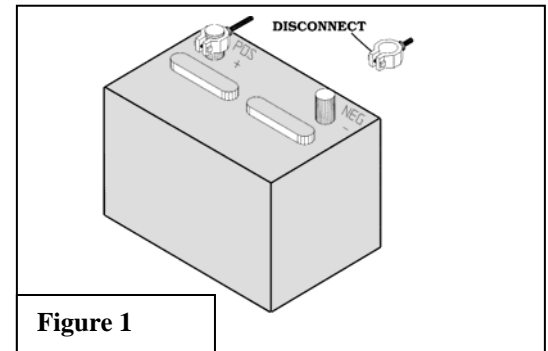

Figure 1



Figure 2

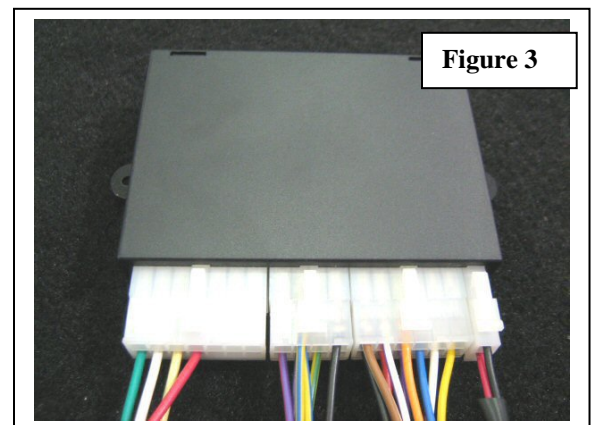

Figure 3

4. Locate the 6 pin **plug and mate connectors** on the Pedal Interface Harness. Remove the accelerator 6-pin connector and apply to mating connector of Pedal Interface Harness. Apply the other connector to the accelerator. **Figure 4**

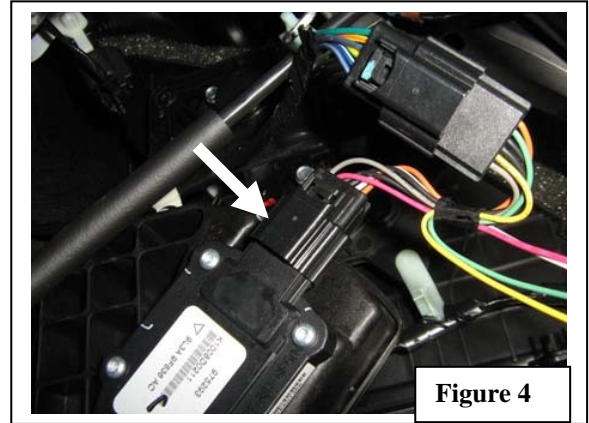

Figure 4

C. Wiring Connections (It is advisable use solder for all wiring connections)



1. Locate the following vehicle wires to connect to the main harness from the control module:

Function	See Fig.	Vehicle Color
IGN	5	WHITE/LT. BLUE
BRAKE +	6	YELLOW/RED
BRAKE -	6	VIOLET/WHITE
GROUND	7	BLACK/VIOLET
VSS	8-10	BROWN/GREEN
CLUTCH SWITCH	11	GREEN/VIOLET

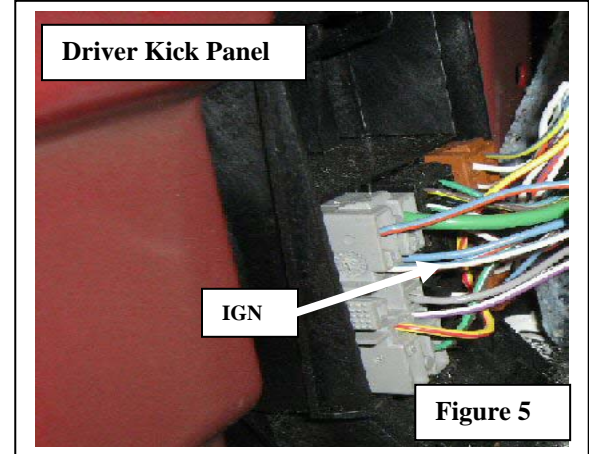

Figure 5

2. Connect the Main Harness to vehicle wire by using the chart below:

Function	Cruise Harness Color	Vehicle Wire
IGN	RED	LT.BLUE/WHITE
BRAKE +	BLUE	YELLOW/RED
BRAKE -	WHITE/BROWN	VIOLET/WHITE
VSS	VIOLET	BROWN/GREEN
CLUTCH SWITCH	WHITE	GREEN/VIOLET

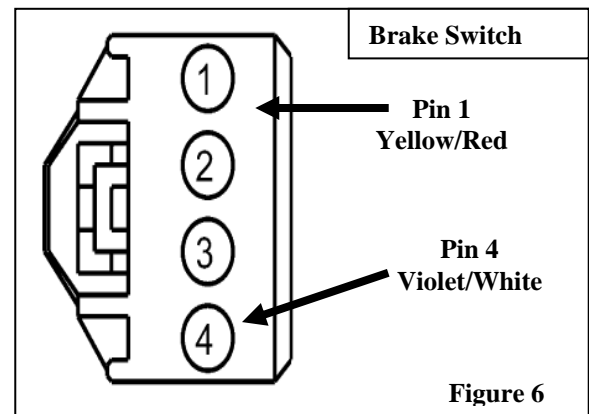

Figure 6

3. Apply the **Black Ground Wire** from the Main Harness to the Vehicle Ground Point at the kick panel. **Figure 7**

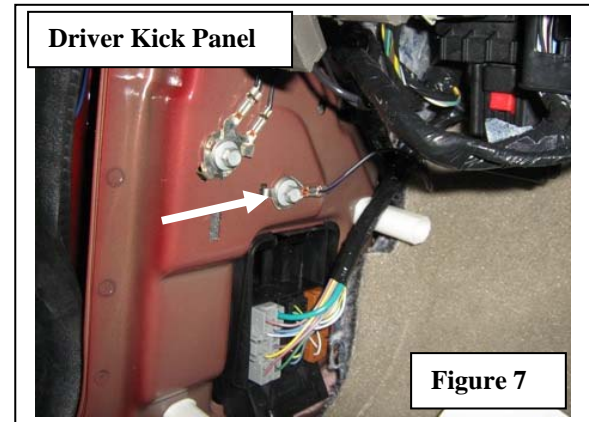
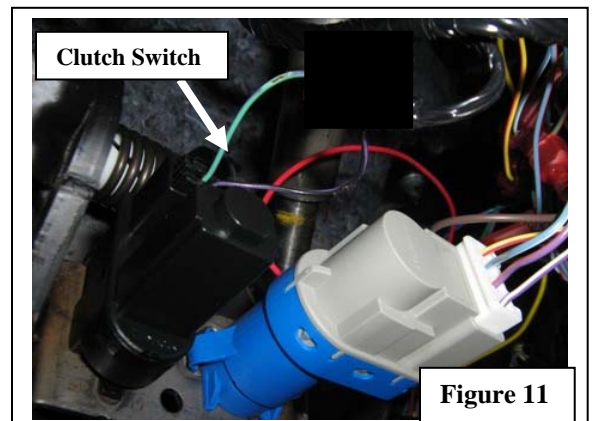
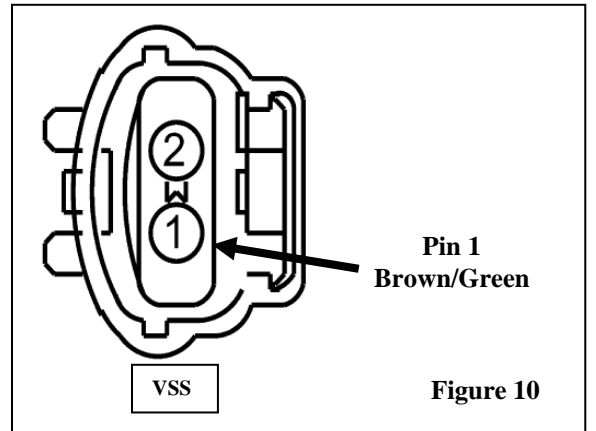
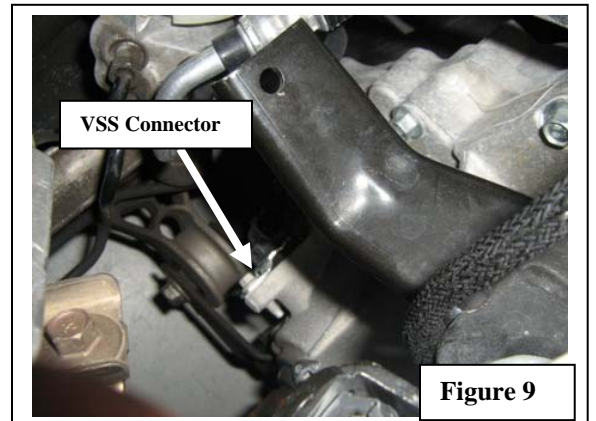
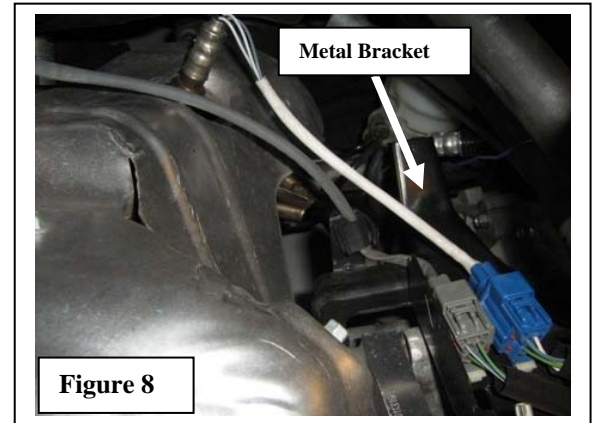

Figure 7

4. **VSS:** For reference, find the metal bracket in front of the gray and blue connectors at the center of the engine compartment. **Figure 8.** Locate the gray 2-pin or (3-pin manual transmission) connector on the transmission below the bracket. **Figure 9. Note: The 3-pin connector will be covered with foil tape.** Connect the **Violet Wire** from the Main Wiring Harness to the **Brown/Green Wire (VSS)** of the connector. Note: If extra length is needed, use the **White/Purple** wire to extend Violet Wire. **Apply the supplied weather sealant to the connection in the engine compartment.** Be sure all of connection is sealed properly. **Figure 10**
5. **Clutch Switch for Manual Transmissions:** Locate the black 2-pin connector on the clutch switch. Connect the **White Wire** from the Main Wiring harness to the **Green /Violet Wire** of the clutch switch. Secure Cruise Control and Switch Interface Module harnesses with zip ties away from moving parts. **Figure 10**



D. Install Control Switch



1. Use the **level wedges** on the Control Switch at an angle template to drill a 3/8" or 9.5mm hole in the lower shroud of the steering column cover. Position lock-washers as shown. **Figures 12-13**
2. Apply nut and position Control Switch for driver's best view.
3. Assemble (2) 3-pin connectors from the sack parts to the mating wire colors on the Control switch harness. Use the diagram to mate the module harness to switch harness. **Figure 14**
4. Route the assembled Control Switch harness to the mating connector of the Cruise Control module.
5. Secure the Control Switch harness with zip ties away from moving parts.

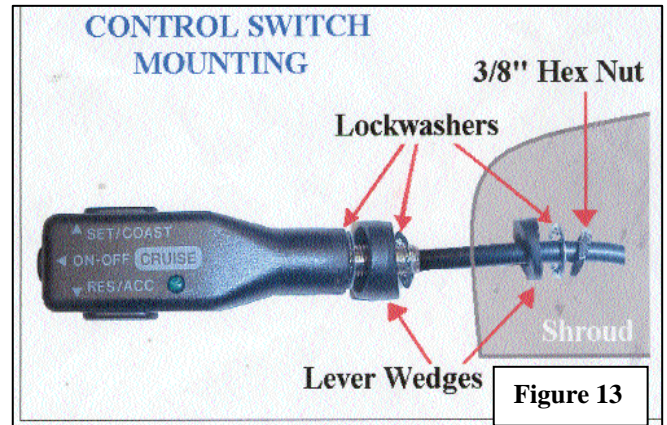
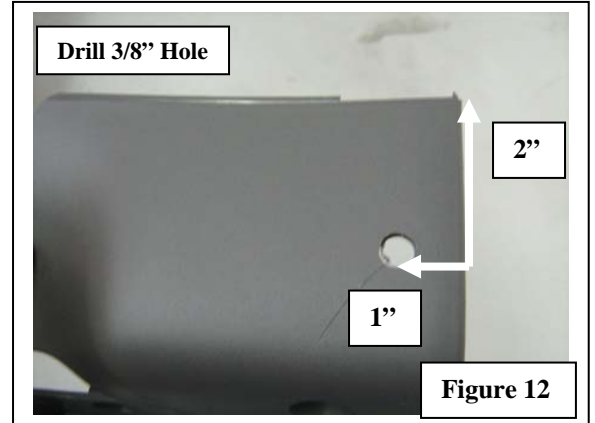

E. Testing



1. Reconnect negative battery cable and torque to 35 in*lbs. Reenter anti-theft radio codes.



2. Turn ignition on. Apply the on/off button of Cruise Control Switch.

F. Reassembly



1. Reinstall all removed pieces taking care to ensure harnesses and wiring connections are properly secured.
2. Make sure all harnesses are not pinched or bound by trim pieces.

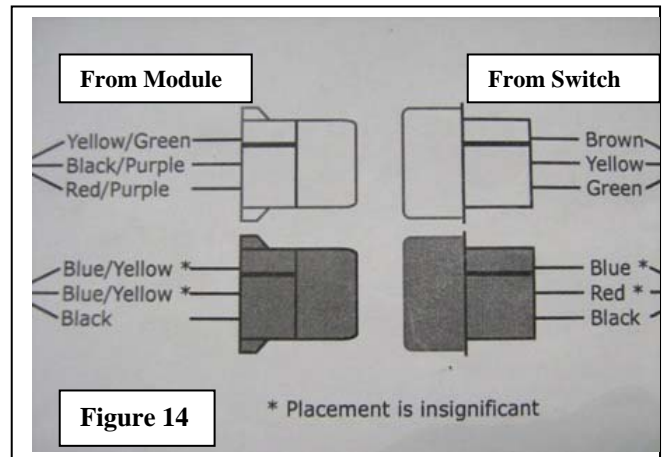

Section II - Wiring Diagram

Note: All Pedal Interface Harness Voltages at cruise module are with pedal fully depressed

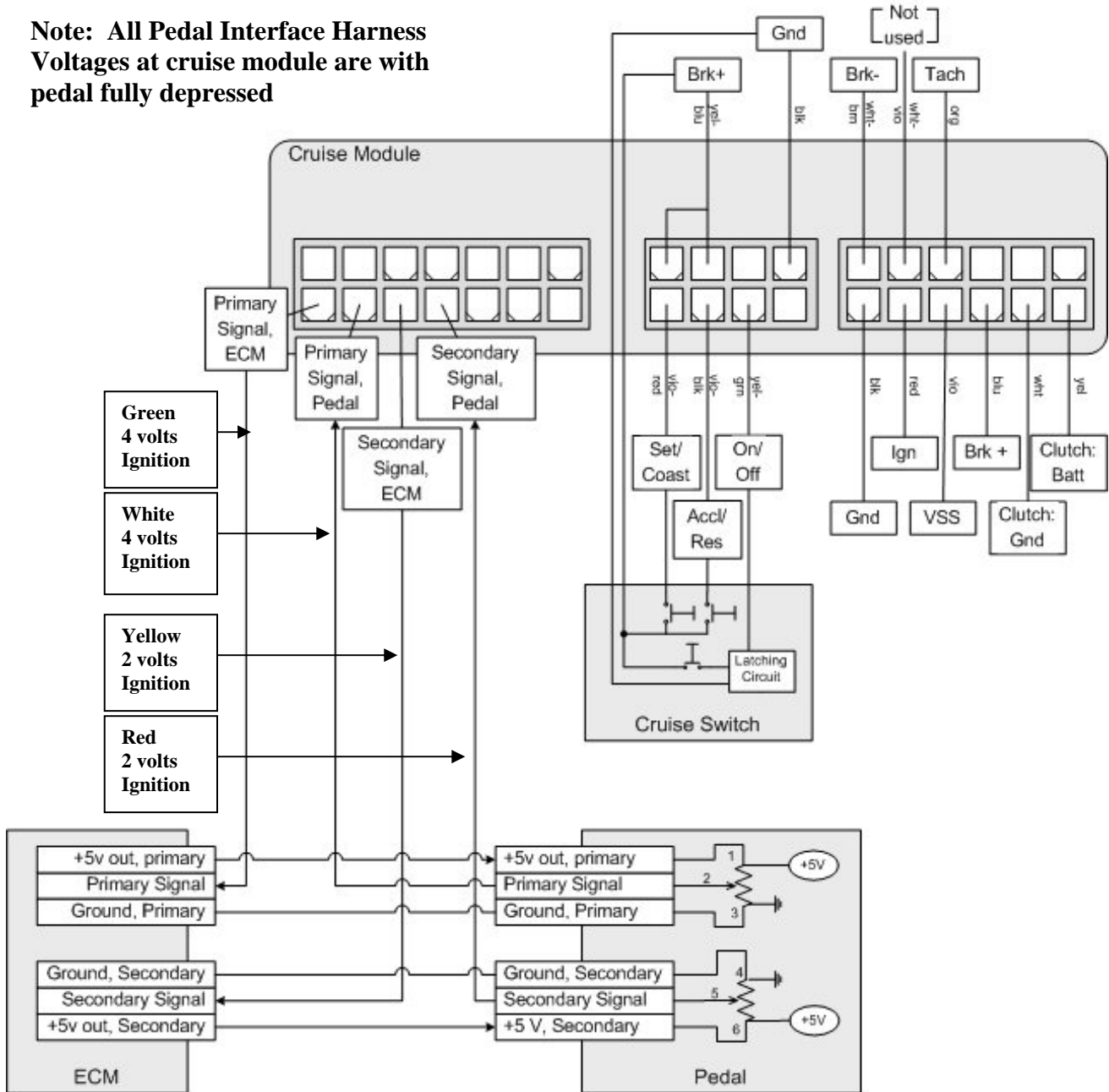

WIRING HARNESS DESCRIPTION

Function	Color	Results	Fault Conditions
Ignition	Red	+12V when switched on and +0V when switched off. Ignition must be greater than +10V while cranking vehicle.	No power, voltage drop, or intermittent connection will cause Loss of pedal or "Limp Mode" condition.
Brake positive +	Blue	"Hot" side of brake switch. +12V all the time.	Cruise will not function if this connection is not installed correctly.
Brake negative -	Brown/White	"Cold" side of Brake switch. Zero (0) resistance to ground when brake is not pressed. +12V when brake is pressed.	Cruise will not function if this connection is not installed correctly. If connection is good, and there is a high resistance to ground, a 5 terminal relay will be required to complete installation. See diagram below.
Ground	Black	Lowest resistance to ground closest to zero (0) ohms as possible. Use a vehicle ground point where other ground wires are connected to.	A bad ground connection will cause the following conditions: Cruise will not function; Loss of pedal or "Limp Mode" condition.
Clutch (GND triggered)	White	Ground active wire at switch when clutch is depressed.	Cruise will not function if wrong wire is connected –OR– ⚠️Cruise will not disengage when clutch is depressed.
Clutch (+12V triggered)	Yellow	+12V active wire at switch when clutch is depressed.	Cruise will not function if wrong wire is connected –OR– ⚠️Cruise will not disengage when clutch is depressed.

5 Terminal Relay for Brake Switch

